

PRODUKTINFORMATION



HÄMTFAX
08-580 941 14



FAX ON DEMAND
+46 8 580 941 14



INTERNET
<http://www.elfa.se>

TEKNISK INFORMATION 020-75 80 20 ORDERTEL 020-75 80 00 ORDERFAX 020-75 80 10

TECHNICAL INFORMATION +46 8 580 941 15 ORDERPHONE +46 8 580 941 01 ORDERFAX +46 8 580 941 11

— Vi reserverar oss mot fel samt förbehåller oss rätten till ändringar utan föregående meddelande —

ELFA artikelnr.

73-257-72 MAX4112ESA Strömåterk först.

73-257-80 MAX4117ESA Dubbel först.

73-257-98 MAX4119ESD 4-Dubbel först.

Antal sidor: 14



Single/Dual/Quad, 400MHz, Low-Power, Current Feedback Amplifiers

General Description

The single MAX4112/MAX4113, dual MAX4117/MAX4118, and quad MAX4119/MAX4120 current feedback amplifiers combine high-speed performance with low-power operation. The MAX4112/MAX4117/MAX4119 are optimized for closed-loop gains of 2V/V or greater, while the MAX4113/MAX4118/MAX4120 are optimized for gains of 8V/V or greater.

The MAX4112/MAX4117/MAX4119 and the MAX4113/MAX4118/MAX4120 require only 5mA of supply current per channel, and deliver 0.1dB gain flatness up to 115MHz and -3db bandwidths of 400MHz ($A_V \geq 2V/V$) and 300MHz ($A_V \geq 8V/V$), respectively. Their high slew rates of up to 1800V/ μ s provide exceptional full-power bandwidths up to 280MHz, making these amplifiers ideal for high-performance pulse and RGB video applications.

These high-speed op amps have a wide output voltage swing of $\pm 3.5V$ into 100 Ω and a high current-drive capability of 80mA.

Applications

- Broadcast and High-Definition TV Systems
- RGB Video
- Pulse/RF Amplifier
- Ultrasound/Medical Imaging
- Active Filters
- High-Speed ADC Buffers
- Professional Cameras
- High-Definition Surveillance

Features

- ◆ 400MHz -3dB Bandwidth (MAX4112/MAX4117)
- ◆ 270MHz -3dB Bandwidth (MAX4113/MAX4119)
- ◆ 300MHz -3dB Bandwidth (MAX4118/MAX4120)
- ◆ 0.1dB Gain Flatness to 115MHz
- ◆ 1200V/ μ s Slew Rate (MAX4112/MAX4117/MAX4119)
- ◆ 1800V/ μ s Slew Rate (MAX4113/MAX4118/MAX4120)
- ◆ 280MHz Full-Power Bandwidth ($V_O = 2V_{p-p}$, MAX4112/MAX4117)
- ◆ 240MHz Full-Power Bandwidth ($V_O = 2V_{p-p}$, MAX4113/MAX4118/MAX4120)
- ◆ High Output Drive: 80mA
- ◆ Low Power: 5mA Supply Current per Channel

Ordering Information

PART	TEMP. RANGE	PIN-PACKAGE
MAX4112ESA	-40°C to +85°C	8 SO
MAX4112EUA	-40°C to +85°C	8 μ MAX*
MAX4113ESA	-40°C to +85°C	8 SO
MAX4117ESA	-40°C to +85°C	8 SO
MAX4118ESA	-40°C to +85°C	8 SO

Ordering Information continued at end of data sheet.

* Contact factory for μ MAX package availability.

Pin Configurations

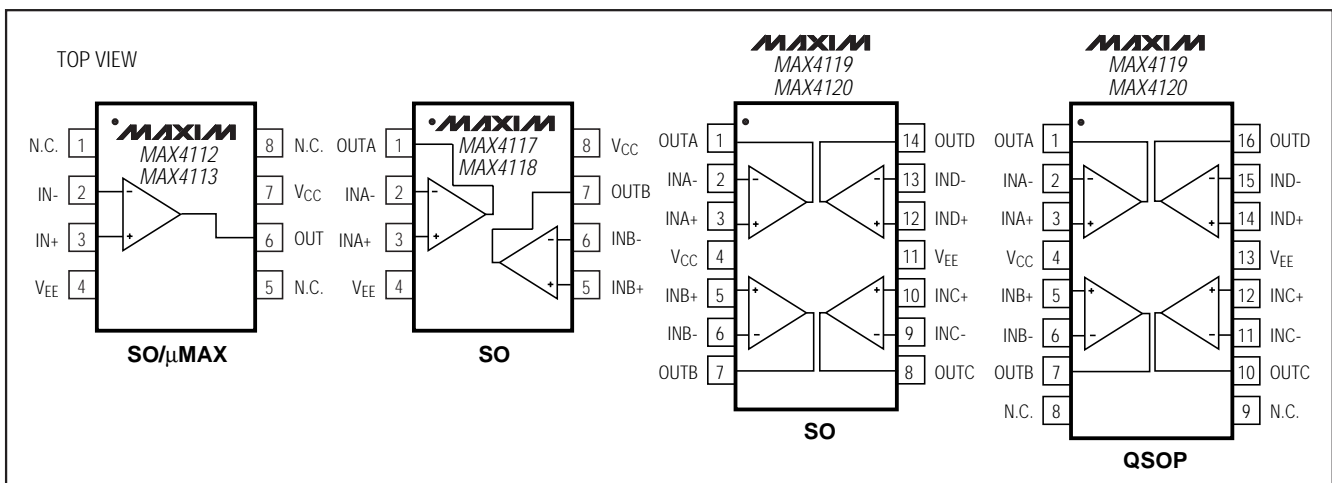

MAX4112/MAX4113/MAX4117-MAX4120

Single/Dual/Quad, 400MHz, Low-Power, Current Feedback Amplifiers

ABSOLUTE MAXIMUM RATINGS

Power-Supply Voltage (V_{CC} to V_{EE}).....	12V	8-Pin μ MAX (derate 4.10mW/°C above +70°C)	330mW
Input Voltage (IN_+ , IN_-).....	($V_{CC} + 0.3V$) to ($V_{EE} - 0.3V$)	14-Pin SO (derate 8.33mW/°C above +70°C).....	667mW
IN_- Current (Note 1)	$\pm 10mA$	16-Pin QSOP (derate 9.52mW/°C above +70°C).....	762mW
Short-Circuit Duration (V_{OUT} to GND)		Operating Temperature Range	
$V_{IN} < 1.5V$	Continuous	MAX41__E_.....	-40°C to +85°C
$V_{IN} > 1.5V$	0sec	Storage Temperature Range	-65°C to +160°C
Continuous Power Dissipation ($T_A = +70^\circ C$)		Lead Temperature (soldering, 10sec)	+300°C
8-Pin SO (derate 5.88mW/°C above +70°C).....	471mW		

Stresses beyond those listed under "Absolute Maximum Ratings" may cause permanent damage to the device. These are stress ratings only, and functional operation of the device at these or any other conditions beyond those indicated in the operational sections of the specifications is not implied. Exposure to absolute maximum rating conditions for extended periods may affect device reliability.

ELECTRICAL CHARACTERISTICS

($V_{CC} = +5V$, $V_{EE} = -5V$, $T_A = T_{MIN}$ to T_{MAX} , unless otherwise noted. Typical values are at $T_A = +25^\circ C$.) (Note 1)

PARAMETER	SYMBOL	CONDITIONS	MIN	TYP	MAX	UNITS
DC SPECIFICATIONS ($R_L = \infty$, unless otherwise noted)						
Input Offset Voltage	V_{OS}	$V_{OUT} = 0V$		1	8	mV
Input Offset Voltage Drift	TCV_{OS}	$V_{OUT} = 0V$		10		$\mu V/^\circ C$
Positive Input Bias Current	I_{B+}	$V_{OUT} = 0V$, $V_{IN} = -V_{OS}$		3.5	20	μA
Negative Input Bias Current	I_{B-}	$V_{OUT} = 0V$, $V_{IN} = -V_{OS}$		3.5	20	μA
Input Resistance		IN_+		500		$k\Omega$
		IN_-		30		Ω
Input Voltage Noise	e_n	$f = 10kHz$		2.2		nV/\sqrt{Hz}
Integrated Voltage Noise	E_{nRMS}	$f = 1MHz$ to $100MHz$		27		μV_{RMS}
Positive Input Current Noise	i_{n+}	$f = 10kHz$	MAX4112/MAX4117/ MAX4119	13		pA/\sqrt{Hz}
			MAX4113/MAX4118/ MAX4120	9		
Negative Input Current Noise	i_{n-}	$f = 10kHz$		14		pA/\sqrt{Hz}
Common-Mode Input Voltage	V_{CM}		-2.5		2.5	V
Common-Mode Rejection	CMR	$V_{CM} = \pm 2.5V$	45	50		dB
Power-Supply Rejection	PSR	$V_S = \pm 4.5V$ to $\pm 5.5V$	60	80		dB
Open-Loop Transimpedance	Z_{OL}	$V_{OUT} = \pm 2.0V$, $V_{CM} = 0V$, $R_L = 100\Omega$	250	500		$k\Omega$
Quiescent Supply Current per Amplifier	I_{SY}	$V_{IN} = 0V$		5	6.5	mA
Output Voltage Swing	V_{OUT}	$R_L = \infty$	± 3.5	± 3.8		V
		$R_L = 100\Omega$	± 3.1	± 3.5		
Output Current Drive	I_{OUT}	$R_L = 30\Omega$, $T_A = 0^\circ C$ to $+85^\circ C$	65	80		mA
AC SPECIFICATIONS ($R_L = 100\Omega$, unless otherwise noted)						
Small Signal -3dB Bandwidth	BWSS	$V_{OUT} \leq 0.1V_{RMS}$	MAX4112/MAX4117	400		MHz
			MAX4113/MAX4119	270		
			MAX4118/MAX4120	300		

Single/Dual/Quad, 400MHz, Low-Power, Current Feedback Amplifiers

MAX4112/MAX4113/MAX4117-MAX4120

ELECTRICAL CHARACTERISTICS (continued)

(V_{CC} = +5V, V_{EE} = -5V, T_A = T_{MIN} to T_{MAX}, unless otherwise noted. Typical values are at T_A = +25°C.) (Note 1)

PARAMETER	SYMBOL	CONDITIONS	MIN	TYP	MAX	UNITS
AC SPECIFICATIONS (R _L = 100Ω, unless otherwise noted) (continued)						
0.1dB Gain Flatness	BW _{0.1dB}	MAX4112/MAX4117/MAX4119, A _{VCL} = +2		100		MHz
		MAX4113/MAX4118/MAX4120, A _{VCL} = +8		115		
Large-Signal -3dB Bandwidth	BW _{LS}	V _{OUT} = 2V _{p-p}	MAX4112/MAX4117	280		MHz
			MAX4119	145		
			MAX4113/MAX4118/ MAX4120	240		
Slew Rate	SR	-2V ≤ V _{OUT} ≤ 2V	MAX4112/MAX4117/ MAX4119	1200		V/μs
			MAX4113/MAX4118/ MAX4120	1800		
Settling Time	t _s	to 0.1%, -1V ≤ V _{OUT} ≤ 1V	MAX4112/MAX4117/ MAX4119	15		ns
			MAX4113/MAX4118/ MAX4120	10		
		to 0.01%, -1V ≤ V _{OUT} ≤ 1V	MAX4112/MAX4117/ MAX4119	35		
			MAX4113/MAX4118/ MAX4120	25		
Rise/Fall Times	t _r , t _f	10% to 90%, -2V ≤ V _{OUT} ≤ 2V		3		ns
		10% to 90%, -50mV ≤ V _{OUT} ≤ 50mV		0.8		
Differential Gain	DG	f = 3.58MHz, R _L = 150Ω	MAX4112/MAX4117/ MAX4119, A _{VCL} = +2	0.02		%
			MAX4113/MAX4118/ MAX4120, A _{VCL} = +8	0.02		
Differential Phase	DP	f = 3.58MHz, R _L = 150Ω	MAX4112/MAX4117/ MAX4119, A _{VCL} = +2	0.03		degrees
			MAX4113/MAX4118/ MAX4120, A _{VCL} = +8	0.04		
Input Capacitance	C _{IN}			2		pF
Output Impedance	Z _{OUT}	f = 10MHz, A _{VCL} = +2		0.9		Ω
Spurious-Free Dynamic Range	SFDR	f _C = 5MHz, V _{OUT} = 2V _{p-p}	MAX4112/MAX4117/ MAX4119, A _{VCL} = +2	-68		dBc
			MAX4113/MAX4118/ MAX4120, A _{VCL} = +8	-62		
Two-Tone Third-Order Intercept	IP ₃	MAX4112/MAX4117/MAX4119, f _C = 10MHz, f _{C1} = 10.1MHz, A _{VCL} = +2		36		dB
Crosstalk		All hostile, V _{IN} = 1V _{p-p} , f = 10MHz		-75		dB

Note 1: The MAX4112/MAX4113/MAX4117-MAX4120 are designed to operate in a closed-loop configuration in which the IN- pin is driven by the OUT pin through an external feedback network. If an external voltage source is connected to IN-, current into or out of IN- must be limited to ±10mA, to prevent damage to the part.

Single/Dual/Quad, 400MHz, Low-Power, Current Feedback Amplifiers

Typical Operating Characteristics

($V_{CC} = +5V$, $V_{EE} = -5V$, $R_F = 499\Omega$, $R_L = 100\Omega$, $T_A = +25^\circ C$, unless otherwise noted.)

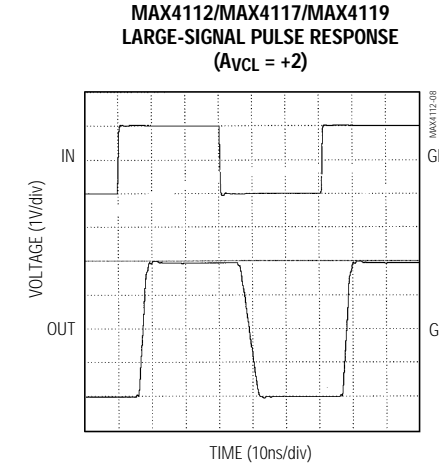
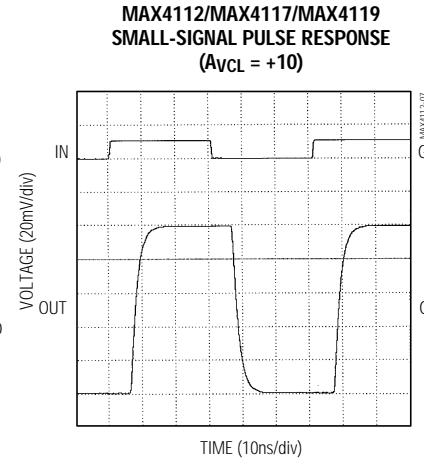
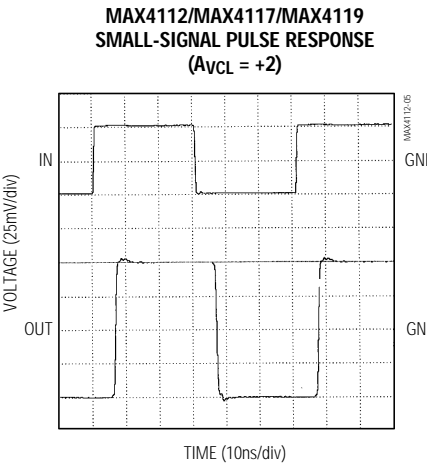
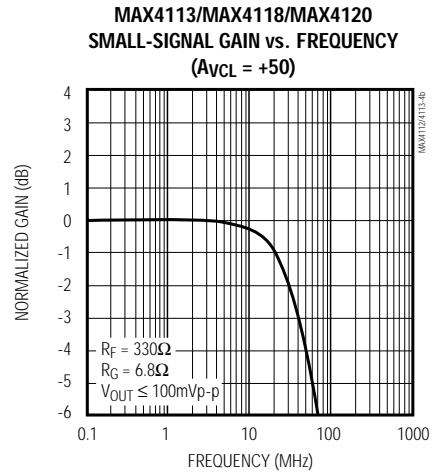
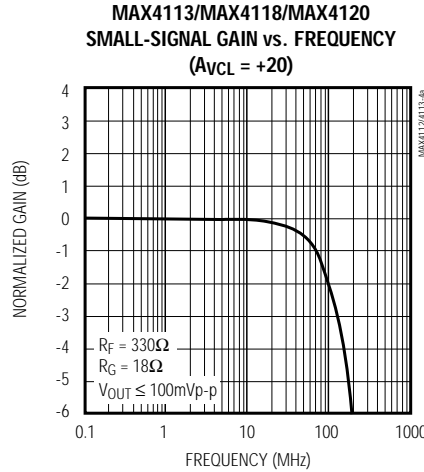
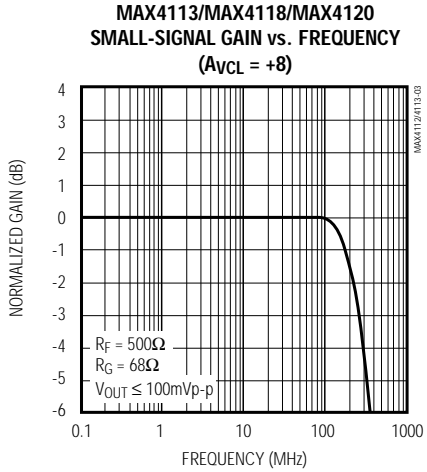
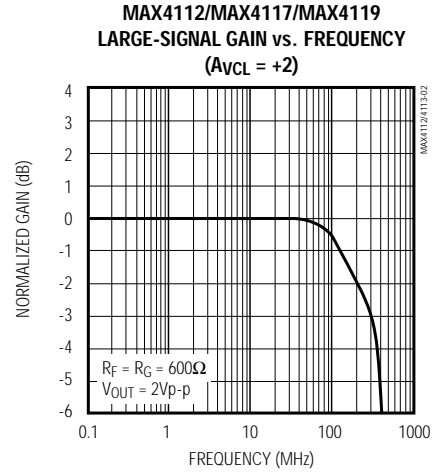
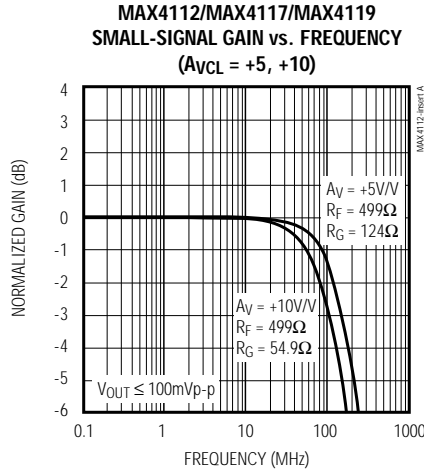
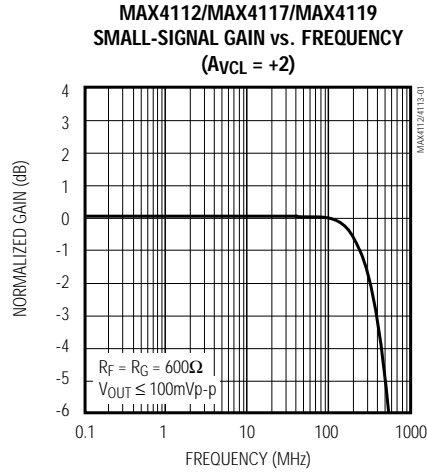

Single/Dual/Quad, 400MHz, Low-Power, Current Feedback Amplifiers

Typical Operating Characteristics (continued)

($V_{CC} = +5V$, $V_{EE} = -5V$, $R_F = 499\Omega$, $R_L = 100\Omega$, $T_A = +25^\circ C$, unless otherwise noted.)

**MAX4112/MAX4117/MAX4119
LARGE-SIGNAL PULSE RESPONSE
($A_{vCL} = +10$)**

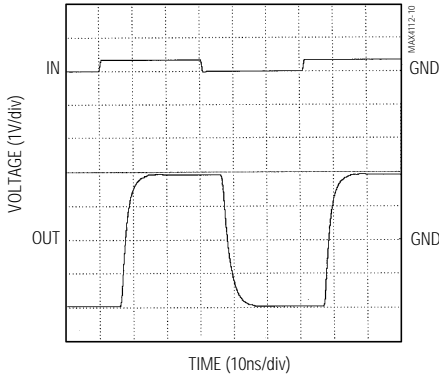

**MAX4112/MAX4117/MAX4119
SMALL-SIGNAL PULSE RESPONSE
($A_{vCL} = +2$, $C_L = 10pF$)**

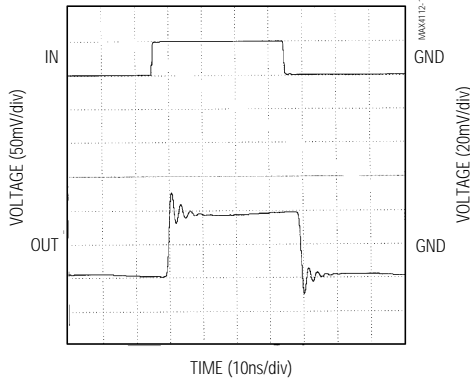

**MAX4113/MAX4118/MAX4120
SMALL-SIGNAL PULSE RESPONSE
($A_{vCL} = +8$)**

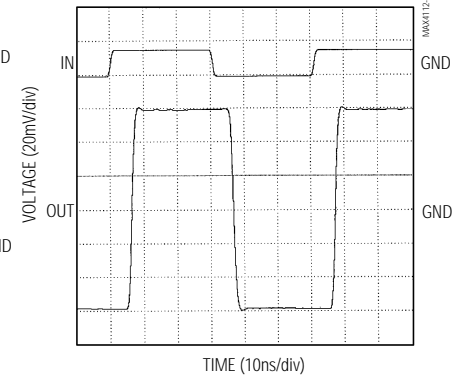

**MAX4113/MAX4118/MAX4120
SMALL-SIGNAL PULSE RESPONSE
($A_{vCL} = +20$)**

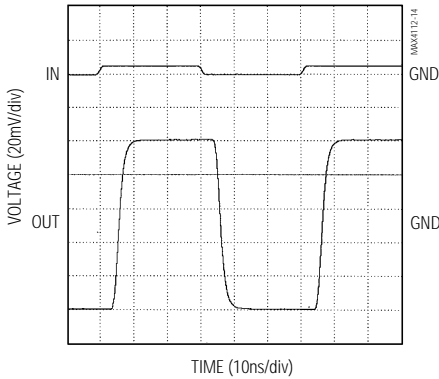

**MAX4113/MAX4118/MAX4120
LARGE-SIGNAL PULSE RESPONSE
($A_{vCL} = +8$)**

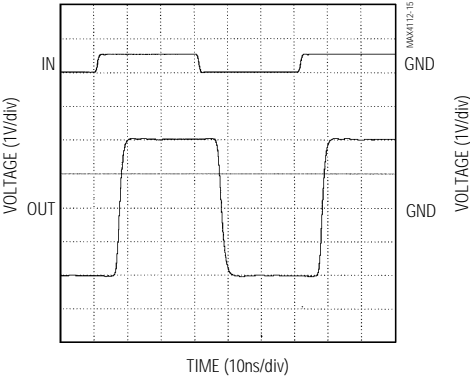

**MAX4113/MAX4118/MAX4120
LARGE-SIGNAL PULSE RESPONSE
($A_{vCL} = +20$)**

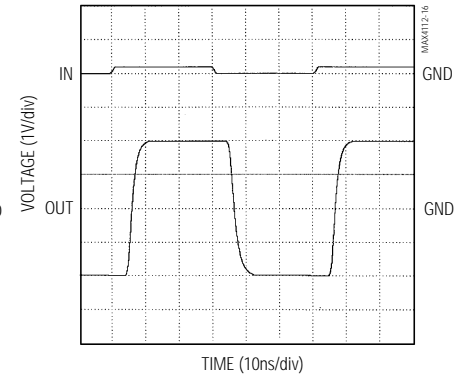

**MAX4112/MAX4117/MAX4119
SETTLING TIME vs. GAIN**

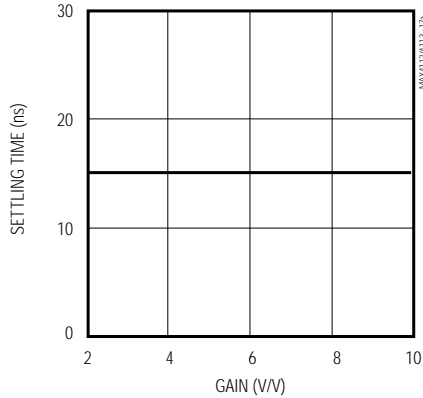

**MAX4113/MAX4118/MAX4120
SETTLING TIME vs. GAIN**

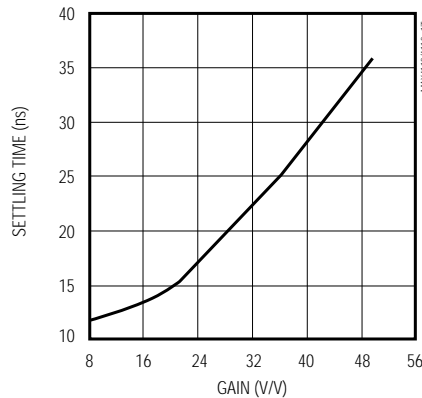

**MAX4117-MAX4120
CROSSTALK vs. FREQUENCY**

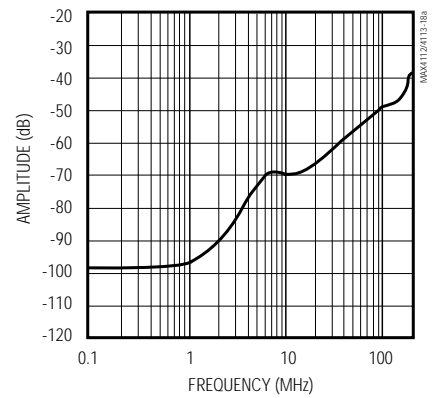

MAX4112/MAX4113/MAX4117-MAX4120

Single/Dual/Quad, 400MHz, Low-Power, Current Feedback Amplifiers

Typical Operating Characteristics (continued)

($V_{CC} = +5V$, $V_{EE} = -5V$, $R_F = 499\Omega$, $R_L = 100\Omega$, $T_A = +25^\circ C$, unless otherwise noted.)

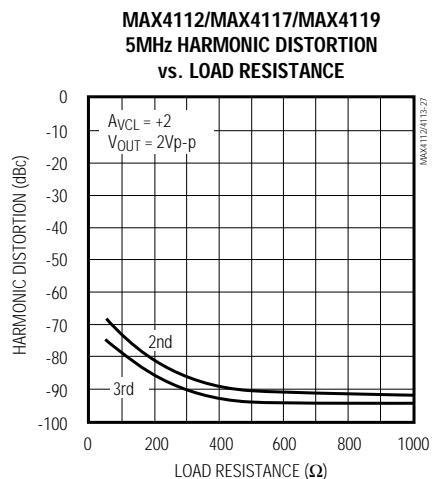
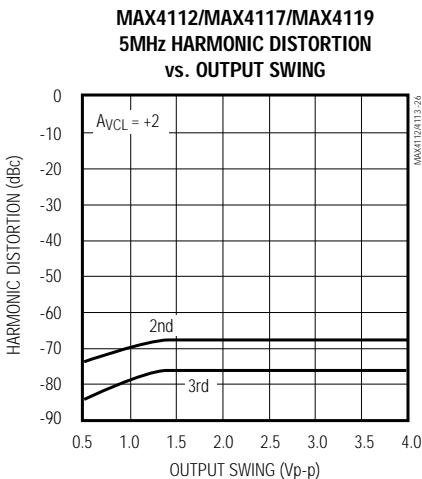
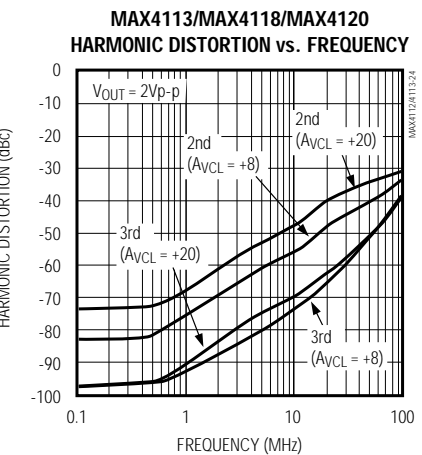
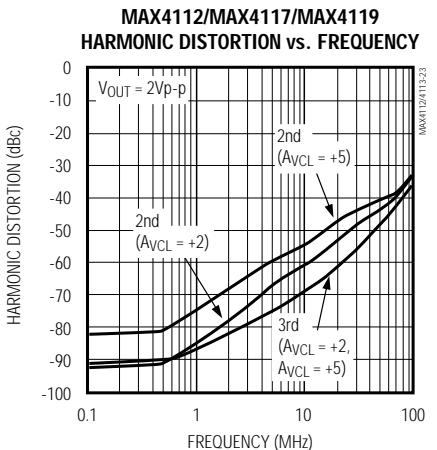
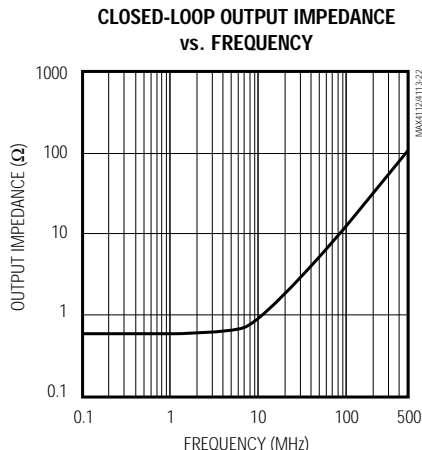
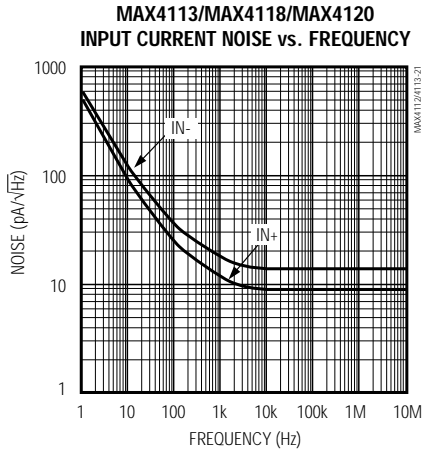
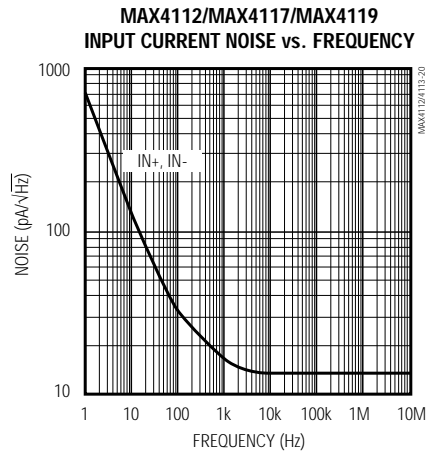
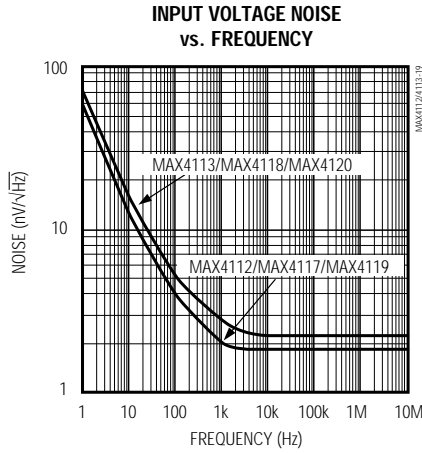
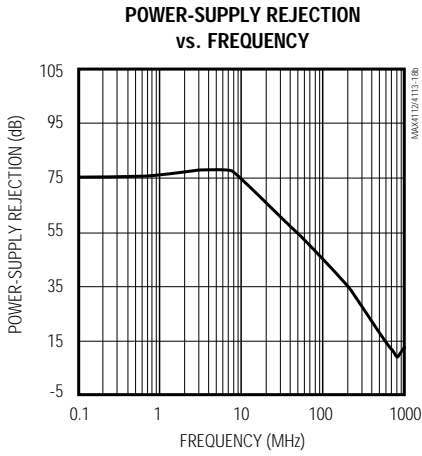

Single/Dual/Quad, 400MHz, Low-Power, Current Feedback Amplifiers

Typical Operating Characteristics (continued)

($V_{CC} = +5V$, $V_{EE} = -5V$, $R_F = 499\Omega$, $R_L = 100\Omega$, $T_A = +25^\circ C$, unless otherwise noted.)

**MAX4113/MAX4118/MAX4120
5MHz HARMONIC DISTORTION
vs. OUTPUT SWING**

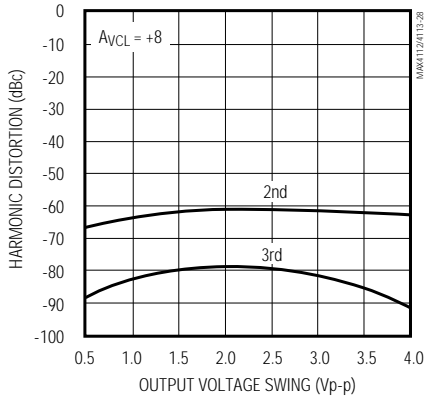

**MAX4113/MAX4118/MAX4120
5MHz HARMONIC DISTORTION
vs. LOAD RESISTANCE**

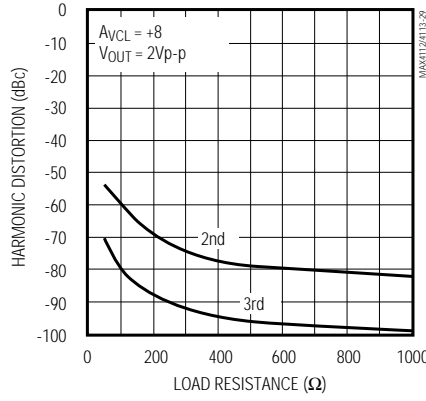

**TWO-TONE THIRD-ORDER INTERCEPT
vs. FREQUENCY**

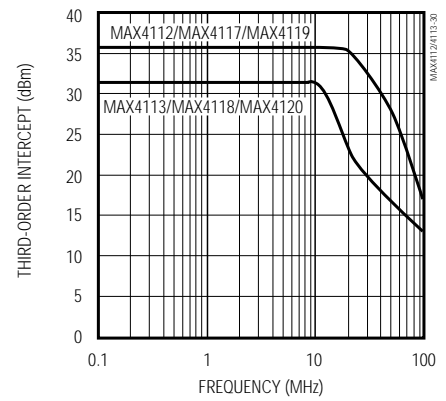

**MAX4112/MAX4117/MAX4119
DIFFERENTIAL GAIN and PHASE**

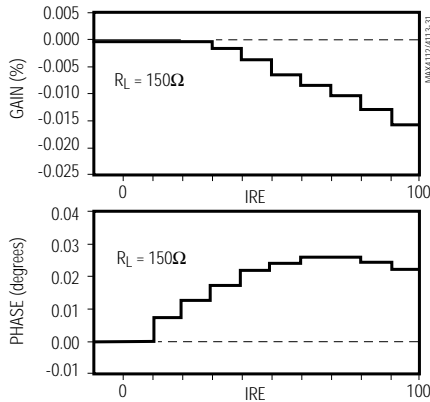

**MAX4113/MAX4118/MAX4120
DIFFERENTIAL GAIN and PHASE**

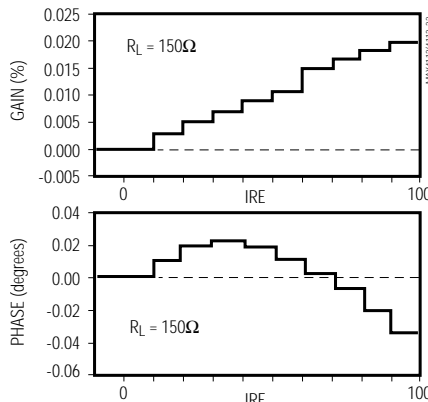

**OPEN-LOOP TRANSIMPEDANCE
vs. TEMPERATURE**

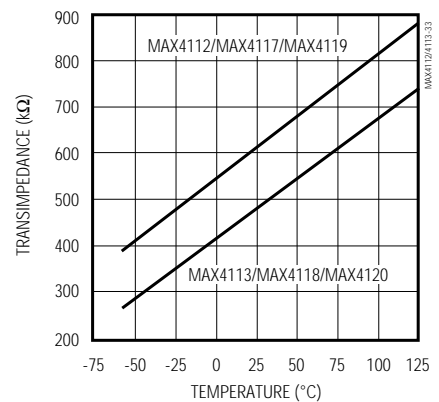

**POSITIVE OUTPUT VOLTAGE SWING
vs. TEMPERATURE**

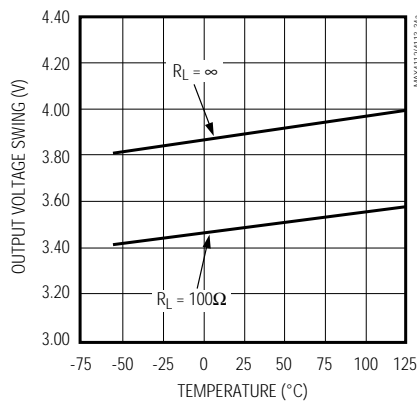

**NEGATIVE OUTPUT VOLTAGE SWING
vs. TEMPERATURE**

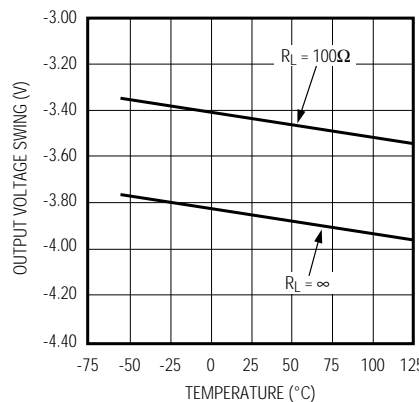

**POSITIVE INPUT BIAS CURRENT
vs. TEMPERATURE**

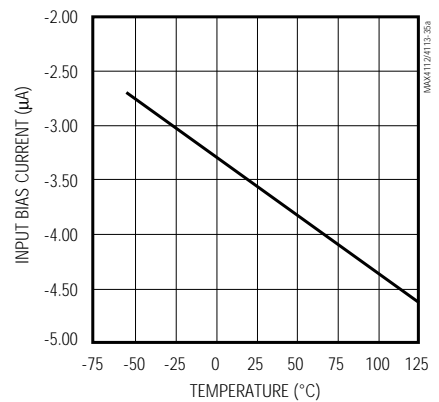

MAX4112/MAX4113/MAX4117-MAX4120

Single/Dual/Quad, 400MHz, Low-Power, Current Feedback Amplifiers

Typical Operating Characteristics (continued)

($V_{CC} = +5V$, $V_{EE} = -5V$, $R_F = 499\Omega$, $R_L = 100\Omega$, $T_A = +25^\circ C$, unless otherwise noted.)

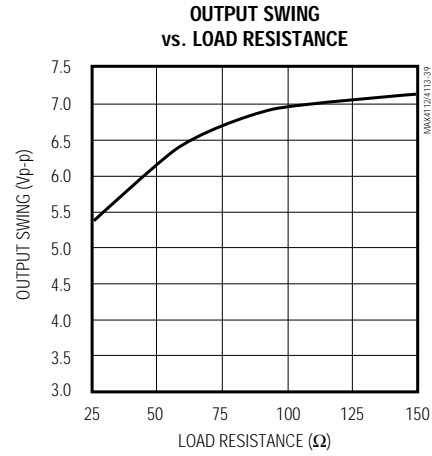
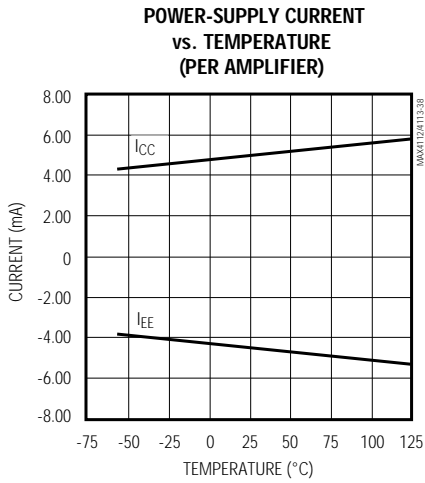
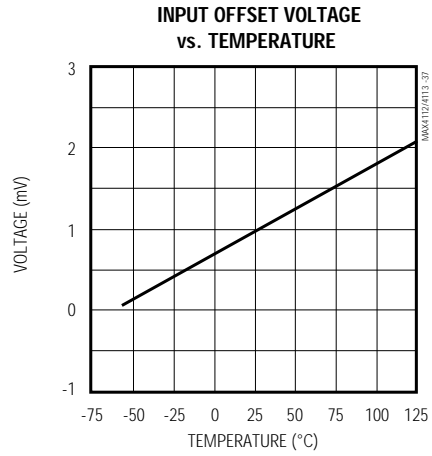
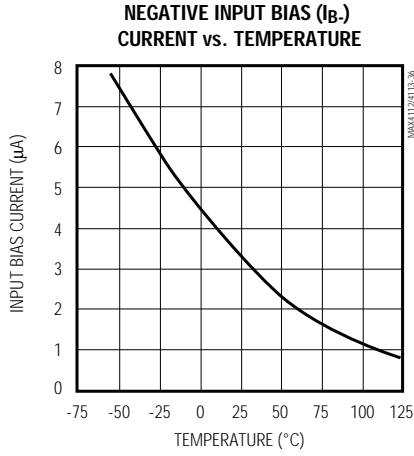

Single/Dual/Quad, 400MHz, Low-Power, Current Feedback Amplifiers

Pin Descriptions

PIN		NAME	FUNCTION
MAX4112 MAX4113 SO/ μ MAX	MAX4117 MAX4118 SO		
1, 5, 8	—	N.C.	No Connection. Not internally connected.
—	1	OUTA	Amplifier A Output
2	—	IN-	Inverting Input
—	2	INA-	Amplifier A Inverting Input
3	—	IN+	Noninverting Input
—	3	INA+	Amplifier A Noninverting Input
4	4	VEE	Negative Power Supply. Connect to -5V.
—	5	INB+	Amplifier B Noninverting Input
6	—	OUT	Amplifier Output
—	6	INB-	Amplifier B Inverting Input
—	7	OUTB	Amplifier B Output
7	8	VCC	Positive Power Supply. Connect to +5V.

PIN		NAME	FUNCTION
SO	QSOP		
1	1	OUTA	Amplifier A Output
2	2	INA-	Amplifier A Inverting Input
3	3	INA+	Amplifier A Noninverting Input
4	4	VCC	Positive Power Supply. Connect to +5V.
5	5	INB+	Amplifier B Noninverting Input
6	6	INB-	Amplifier B Inverting Input
7	7	OUTB	Amplifier B Output
—	8, 9	N.C.	No Connection. Not internally connected.
8	10	OUTC	Amplifier C Output
9	11	INC-	Amplifier C Inverting Input
10	12	INC+	Amplifier C Noninverting Input
11	13	VEE	Negative Power Supply. Connect to -5V.
12	14	IND+	Amplifier D Noninverting Input
13	15	IND-	Amplifier D Inverting Input
14	16	OUTD	Amplifier D Output

Detailed Description

The MAX4112/MAX4117/MAX4119 are optimized for closed-loop gains (A_{VCL}) of 2V/V or greater, while the MAX4113/MAX4118/MAX4120 are optimized for closed-loop gains of 8V/V or greater. These low-power, high-speed, current feedback amplifiers operate from $\pm 5V$ supplies. They are designed to drive video loads with low distortion characteristics. The MAX4112/MAX4117/MAX4119's differential gain and phase are 0.02% and 0.03°, respectively; the MAX4113/MAX4118/MAX4120 exhibit gain/phase error specifications of 0.02% and 0.04°, respectively. These characteristics, plus a wide 0.1dB gain flatness, make the MAX4112/MAX4113/MAX4117-MAX4120 ideal for use

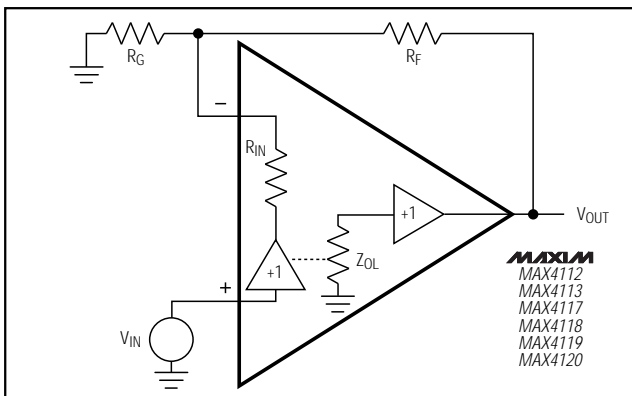

Figure 1. Current Feedback Amplifier

in broadcast and graphics video systems. The combination of ultra-high speed and low power makes these parts suitable for use in general-purpose, high-speed applications, such as medical imaging, industrial instrumentation, and communications systems.

Applications Information

Theory of Operation

Since these devices are current-feedback amplifiers, their open-loop transfer function is expressed as a transimpedance, $\Delta V_{OUT}/\Delta I_{IN}$, or Z_{OL} . The frequency behavior of the open-loop transimpedance is similar to the open-loop gain of a voltage feedback amplifier. That is, it has a large DC value and decreases at approximately 6dB per octave.

Analyzing the follower with gain, as shown in Figure 1, yields the following transfer function:

$$\frac{V_{OUT}}{V_{IN}} = G \times \frac{Z_{OL}(s)}{Z_{OL}(s) + G \times (R_{IN} + R_F)}$$

where $G = A_{VCL} = 1 + (R_F / R_G)$, and $R_{IN} = 1 / g_m \cong 30\Omega$.

Single/Dual/Quad, 400MHz, Low-Power, Current Feedback Amplifiers

At low gains, $G \times R_{IN} \ll R_F$. Therefore, the closed-loop bandwidth is essentially independent of closed-loop gain. Similarly, $Z_{OL} \gg R_F$ at low frequencies, so that:

$$\frac{V_{OUT}}{V_{IN}} = G = 1 + (R_F / R_G)$$

Layout and Power-Supply Bypassing

The MAX4112/MAX4113/MAX4117-MAX4120 have an RF bandwidth and consequently require careful board layout, including the possible use of constant-impedance microstrip or stripline techniques.

To realize the full AC performance of these high-speed amplifiers, pay careful attention to power-supply bypassing and board layout. The PC board should have at least two layers: a signal and power layer on one side, and a large, low-impedance ground plane on the other side. The ground plane should be as free of voids as possible. With multilayer boards, locate the ground plane on a layer that incorporates no signal or power traces.

Regardless of whether a constant-impedance board is used, observe the following guidelines when designing the board. Wire-wrapped boards are much too inductive, and breadboards are much too capacitive; neither should be used. IC sockets increase parasitic capacitance and inductance, and should not be used. In general, surface-mount components give better high-frequency performance than through-hole components. They have shorter leads and lower parasitic reactances. Keep lines as short and as straight as possible. Do not make 90° turns; round all corners.

Observe high-frequency bypassing techniques to maintain the amplifier's accuracy. The bypass capacitors should include a 1000pF ceramic capacitor between each supply pin and the ground plane, located as close to the package as possible. Next, place a

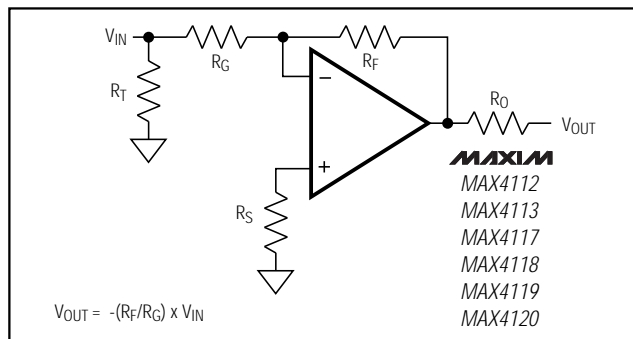

Figure 2a. Inverting Gain Configuration

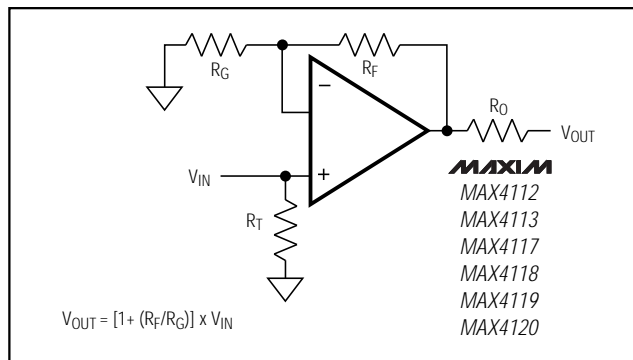

Figure 2b. Noninverting Gain Configuration

0.01µF to 0.1µF ceramic capacitor in parallel with each 1000pF capacitor, and as close to them as possible. Then place a 10µF to 15µF low-ESR tantalum at the point of entry (to the PC board) of the power-supply pins. The power-supply trace should lead directly from the tantalum capacitor to the VCC and VEE pins. To minimize parasitic inductance, keep PC traces short and use surface-mount components.

Table 1. Recommended Component Values

COMPONENT	AvCL = +2			AvCL = +8		
	MAX4112	MAX4117	MAX4119	MAX4113	MAX4118	MAX4120
R _F (Ω)	600	600	500	500	330	330
R _G (Ω)	600	600	500	69	47	47
R _O (Ω)	49.9	49.9	49.9	49.9	49.9	49.9
R _T (Ω)	49.9	49.9	49.9	49.9	49.9	49.9
-3dB Small-Signal Bandwidth (MHz)	400	400	270	270	300	300
0.1dB Gain Flatness (MHz)	100	100	100	115	115	115
Large-Signal Bandwidth (MHz)	280	280	145	240	240	240

Single/Dual/Quad, 400MHz, Low-Power, Current Feedback Amplifiers

MAX4112/MAX4113/MAX4117-MAX4120

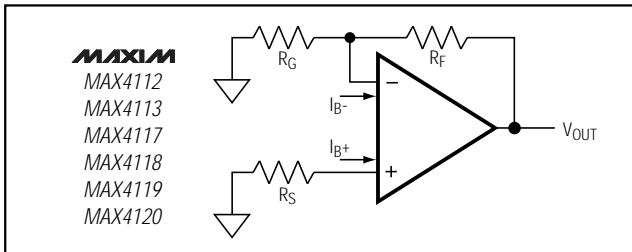

Figure 3. Output Offset Voltage

Choosing Feedback and Gain Resistors

The MAX4112/MAX4113/MAX4117–MAX4120 are current feedback amplifiers. Increasing feedback resistor values will decrease peaking. Use the input resistor (R_G) to change the magnitude of the gain. Figure 2 shows the standard inverting and noninverting configurations. Notice that the gain of the noninverting circuit (Figure 2b) is 1 plus the magnitude of the inverting closed-loop gain (Table 1).

DC and Noise Errors

There are several major error sources to consider in any operational amplifier. These apply equally to the MAX4112/MAX4113/MAX4117–MAX4120. Offset-error terms are given by the equation below. Voltage and current-noise errors are root-square summed and therefore computed separately. In Figure 3, the total output offset voltage is determined by:

- The input offset voltage (V_{OS}) times the closed-loop gain (1 + (R_F / R_G)).
- The positive input bias current (I_{B+}) times the source resistor (R_S) (usually 50Ω or 75Ω), plus the negative input bias current (I_{B-}) times the parallel combination of R_G and R_F. In current-mode feedback amplifiers, the input bias currents may flow into or out of the device. For this reason, there is no benefit to matching the resistance at both inputs.

The equation for total DC error is:

$$V_{OUT} = [(I_{B+})R_S + (I_{B-})(R_F \parallel R_G) + V_{OS}] \left(1 + \frac{R_F}{R_G}\right)$$

- The total output-referred noise voltage is:

$$e_{n(OUT)} = \left(1 + \frac{R_F}{R_G}\right) \sqrt{[(i_{n+})R_S]^2 + [(i_{n-})R_F \parallel R_G]^2 + (e_n)^2}$$

The MAX4112/MAX4117/MAX4119 have a very low, 2nV/√Hz noise voltage. The current noise at the positive input (i_{n+}) is 13pA/√Hz, and the current noise at the inverting input (i_{n-}) is 14pA/√Hz.

An example of the DC error calculations, using the MAX4112 typical data and the typical operating circuit where R_F = R_G = 600Ω (R_F || R_G = 300Ω) and R_S = 50Ω, gives the following:

$$V_{OUT} = (3.5 \times 10^{-6} \times 50 + 3.5 \times 10^{-6} \times 300 + 10^{-3}) (1 + 1)$$

$$V_{OUT} = 4.45\text{mV}$$

Calculating total output noise in a similar manner yields:

$$e_{n(OUT)} = (1+1) \sqrt{(13 \times 10^{-12} \times 50)^2 + (14 \times 10^{-12} \times 300)^2 + (2 \times 10^{-9})^2}$$

$$e_{n(OUT)} = 9.4\text{nV}/\sqrt{\text{Hz}}$$

With a 200MHz system bandwidth, this calculates to 133μV_{RMS} (approximately 797μV_{p-p}, choosing the six-sigma value).

Resistor Types

Surface-mount resistors are the best choice for high-frequency circuits. They are of similar material to metal-film resistors, but are deposited using a thick-film process in a flat, linear manner that minimizes inductance. Their small size and lack of leads also minimizes parasitic inductance and capacitance, yielding more predictable performance.

Metal-film resistors with leads are manufactured using a thin-film process where resistive material is deposited in a spiral layer around a ceramic rod. Although the materials used are noninductive, the spiral winding presents a small inductance (about 5nH) that may have an adverse effect on high-frequency circuits.

Carbon-composition resistors with leads are manufactured by pouring the resistor material into a mold. This process yields relatively low-inductance resistors that are very useful in high-frequency applications, although they tend to cost more and have more thermal noise than other types. The ability of carbon-composition resistors to self-heal after a large current overload makes them useful in high-power RF applications.

For general-purpose use, surface-mount metal-film resistors seem to have the best overall performance for low cost, low inductance, and low noise.

Video Line Driver

The MAX4112/MAX4113/MAX4117–MAX4120 are optimized (gain flatness) to drive coaxial transmission lines when the cable is terminated at both ends, as shown in Figure 4. Cable frequency response can cause variations in the flatness of the signal.

Single/Dual/Quad, 400MHz, Low-Power, Current Feedback Amplifiers

Driving Capacitive Loads

The MAX4112/MAX4113/MAX4117-MAX4120 are optimized for AC performance. They are not designed to drive highly capacitive loads. Reactive loads decrease phase margin and can produce excessive ringing and oscillation. Figure 5a shows a circuit that eliminates this problem. The small (usually 5Ω to 22Ω) isolation resistor, R_S , placed before the reactive load prevents ringing and oscillation. At higher capacitive loads, AC performance is controlled by the interaction of the load capacitance and isolation resistor.

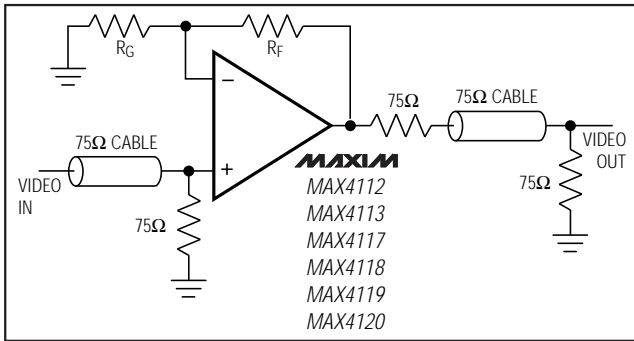

Figure 4. Video Line Driver

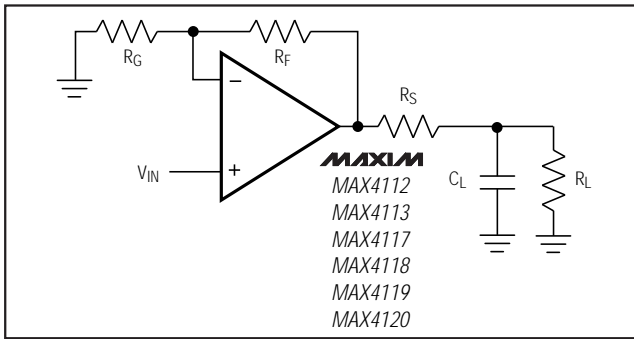

Figure 5a. Using an Isolation Resistor (R_S) for High Capacitive Loads

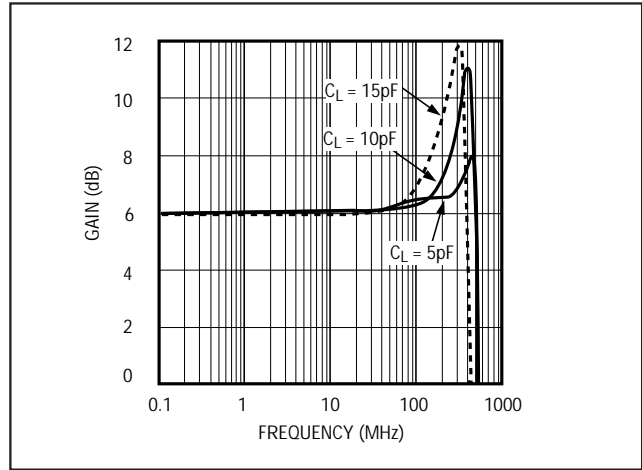

Figure 5b. Frequency Response vs. Capacitive Load—No Isolation Resistor

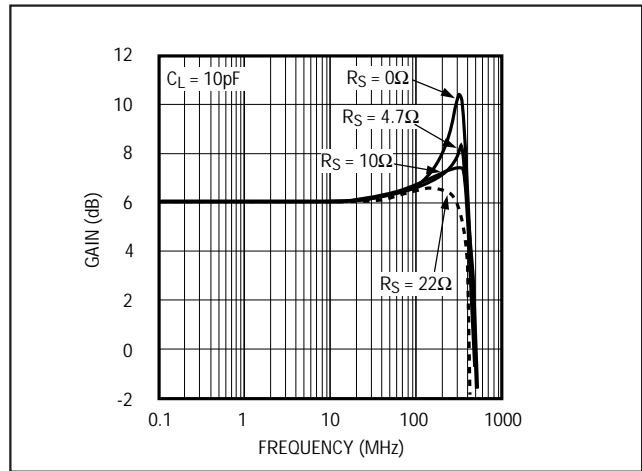

Figure 5c. Frequency Response vs. Isolation Resistance (see Figure 5a for circuit)

_Ordering Information (continued)

PART	TEMP. RANGE	PIN-PACKAGE
MAX4119ESD	-40°C to +85°C	14 SO
MAX4119EEE	-40°C to +85°C	16 QSOP*
MAX4120ESD	-40°C to +85°C	14 SO
MAX4120EEE	-40°C to +85°C	16 QSOP*

*Contact factory for QSOP package availability.

Maxim cannot assume responsibility for use of any circuitry other than circuitry entirely embodied in a Maxim product. No circuit patent licenses are implied. Maxim reserves the right to change the circuitry and specifications without notice at any time.

12 _____ Maxim Integrated Products, 120 San Gabriel Drive, Sunnyvale, CA 94086 (408) 737-7600

Chip Information

TRANSISTOR COUNT: 53 (MAX4112/MAX4113)
112 (MAX4117/MAX4118)
220 (MAX4119/MAX4120)

SUBSTRATE CONNECTED TO V_{EE}

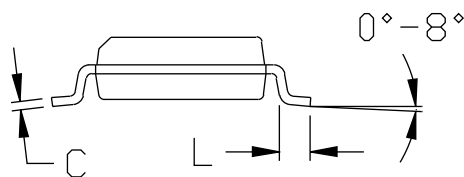
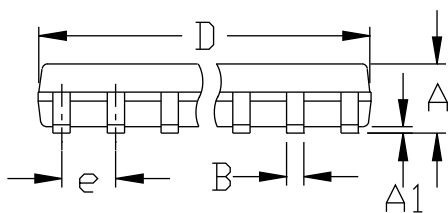
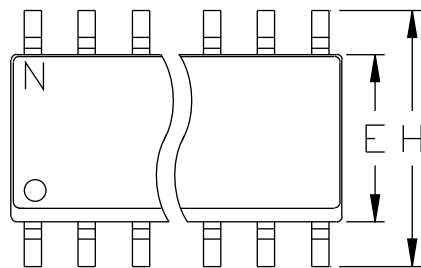

	INCHES		MILLIMETERS	
	MIN	MAX	MIN	MAX
A	0.053	0.069	1.35	1.75
A1	0.004	0.010	0.10	0.25
B	0.014	0.019	0.35	0.49
C	0.007	0.010	0.19	0.25
e	0.050		1.27	
E	0.150	0.157	3.80	4.00
H	0.228	0.244	5.80	6.20
h	0.010	0.020	0.25	0.50
L	0.016	0.050	0.40	1.27

	INCHES		MILLIMETERS		N	MS012
	MIN	MAX	MIN	MAX		
D	0.189	0.197	4.80	5.00	8	A
D	0.337	0.344	8.55	8.75	14	B
D	0.386	0.394	9.80	10.00	16	C

NOTES:

1. D&E DO NOT INCLUDE MOLD FLASH
2. MOLD FLASH OR PROTRUSIONS NOT TO EXCEED .15mm (.006")
3. LEADS TO BE COPLANAR WITHIN .102mm (.004")
4. CONTROLLING DIMENSION: MILLIMETER
5. MEETS JEDEC MS012-XX AS SHOWN IN ABOVE TABLE
6. N = NUMBER OF PINS